

Product Description	Klik Product identification	BS number	Description
Klik Lighting Distribution System	KLDS	BS 5733:2010	General requirements for Electrical Accessories
Occupancy Sensor	EEK*W	IEC 60669-1, IEC 60669-2-1	Switches for household & similar fixed electrical installations Part 2-1 for Electronic switches.
Mounting Boxes	MB	BS 6972:1988	General requirements for Luminaire supporting couplers for domestic, light industrial & commercial use
Mounting Boxes	MP	BS 5733:2010	General requirements for Electrical Accessories
Klik Ceiling Roses, Plugs, Outlets & Pre-Wired Leads	S, P, PCR	BS 5733:2010 BS 6972:1988	General requirements for Electrical Accessories General requirements for Luminaire supporting couplers for domestic, light industrial & commercial use
PVC Flexible Cord	PVC	BS 6500:2000	Flexible cords rated to 300/350V for use with appliances & equipment intended for domestic, office & similar environments.
LSF Flexible Cord	LSF	BS 6500:2000 BS 7211:1998	Flexible cords rated to 300/350V for use with appliances & equipment intended for domestic, office & similar environments.

Product Materials

Klik plugs and sockets feature solid brass terminals and phosphor bronze contacts for good conductivity. Moulded components are manufactured from high quality thermoplastics.

Klik Terminal Capacities

	Number of Conductors				
	0.75mm ²	1.0mm ²	1.5mm ²	2.5mm ²	4.0mm ²
Socket Outlets	-	5	4	3	2
Plugs P22, P64X, P26	1	1	-	-	-

Cables for Klik Plugs

	0.75mm ² PVC / LSF 3 Core	0.75mm ² PVC / LSF 4 Core	1.0mm ² PVC / LSF 3 Core	1.0mm ² PVC / LSF 4 Core
P22	Y	-	Y	-
P64AX	Y	Y	Y	Y

Application Notes

The mating face of each interface module must be mounted 0.1mm minimum proud of its proposed surround. Engaged plug sits centrally on socket but a minimum of 12mm extra clearance should be maintained north of the upper load grip to allow plug travel.

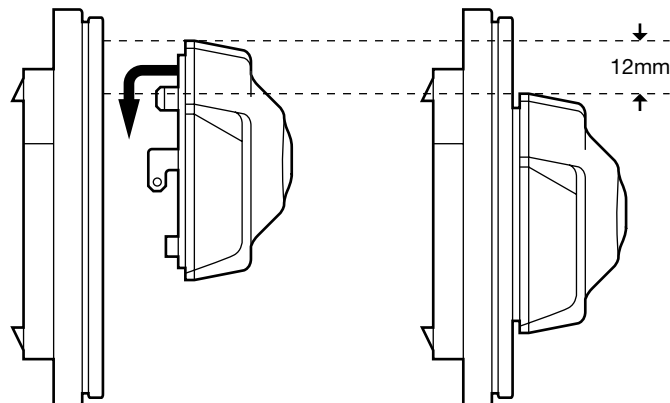

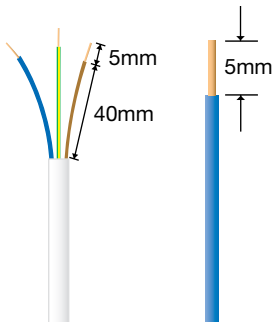

1. Strip cable as above -
Note: Trim cable tails to double over for better terminal contact.

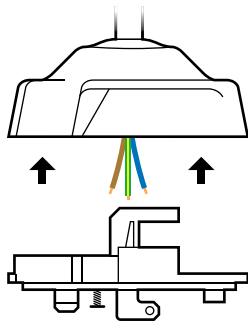

2. Remove plug cover.

3. Pass cable through plug cover centre hole.

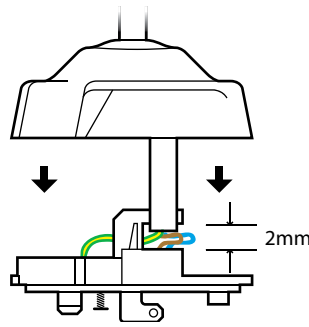

4. Terminate conductors into terminals.

5. Push outer sheath of cable firmly into jaws of sheath grip, making sure that at least 2mm of sheath protrudes below the grip.

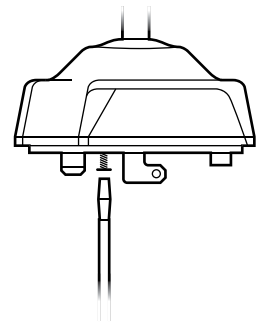

6. Refit cover.

Klik Mounting Box Installation

Cable entry through spout in base of box for maximum wiring space.

MB2 knockouts in base and sides. Supplied with M4 x 20mm long fixing screws.

Flush Mounting for Solid Walls

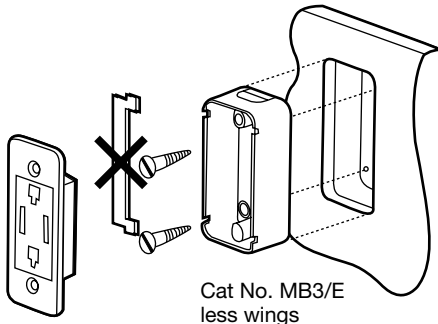

Cat No. MB3/E
less wings

Cat No. S21

Mounting Methods

- Hanging from ceiling suspension system with Caddy Clips™
- Direct fixing to lighting trunking
- Direct fixing to ceiling or wall with No. 8 screws

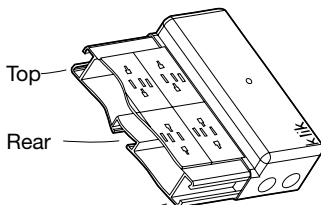

Drop rods on sides



Screw to surface



Drop rods on rear



Bottom

PCR2000

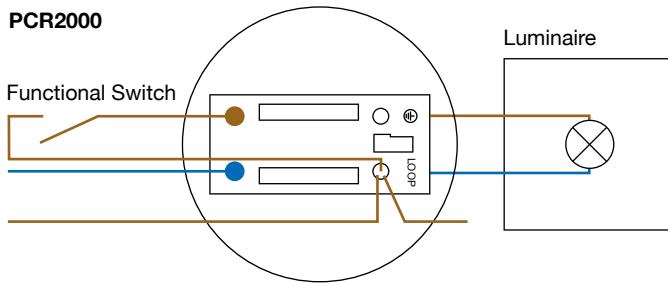

CR64AX

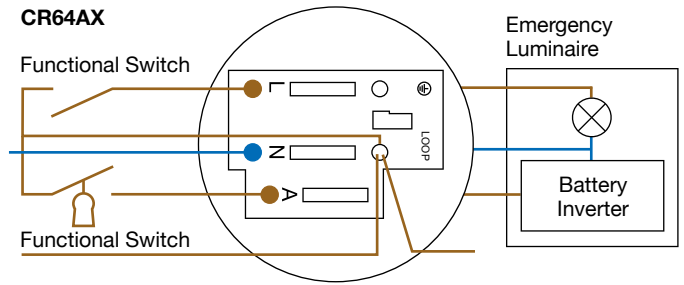

CR64AX

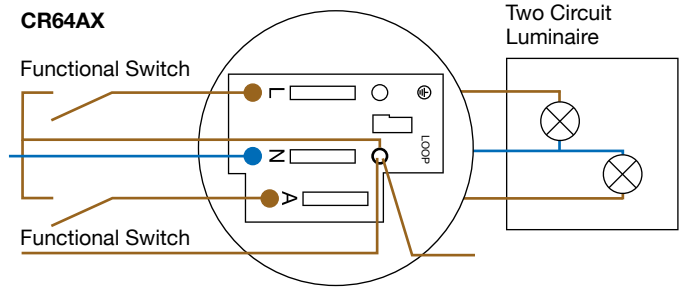

Note: earth connections omitted for clarity

Local Lighting Switch Control Permanent emergency feed

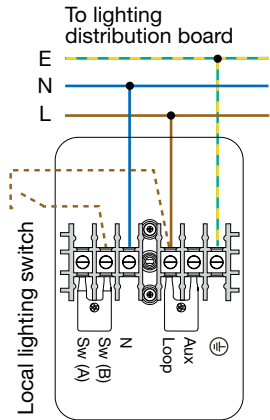

Local Lighting Switch Control Centralised emergency test via keyswitch

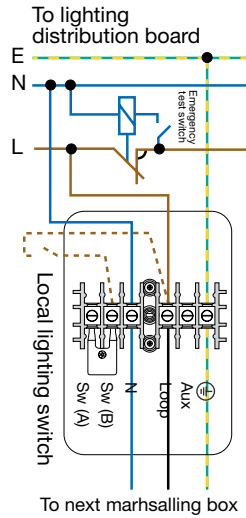

Zone Lighting Control Local emergency test control

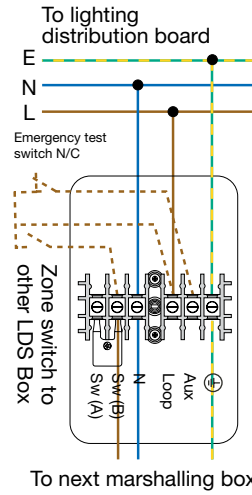

All ways switched by a single Hager EEK513W occupancy sensor

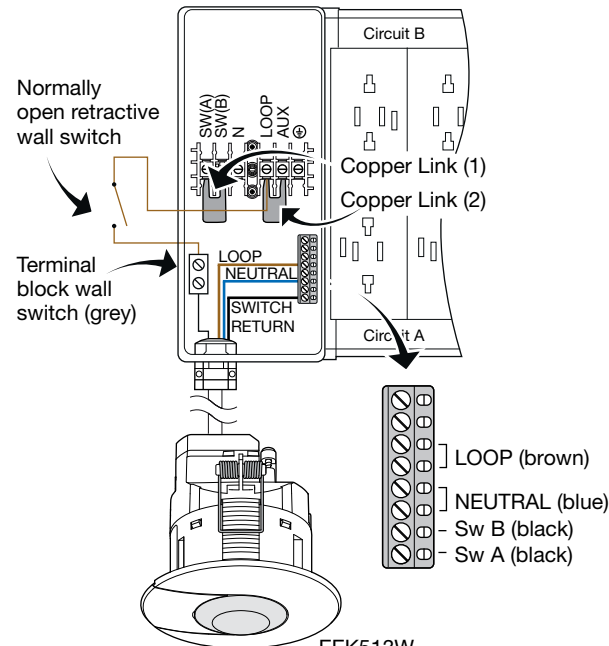

Switch wire to be connected as required.

Connected directly to a single luminaire

